

Western Warship Combat Club, Inc.

2020 Rule Book



www.westernwarshipcombat.com

WESTERN WARSHIP COMBAT CLUB, INC. RULES

CALENDAR YEAR 2016

The rules herein provide a reasonable set of guidelines that will enable all members to enjoy our hobby. Our expectations are that all members, in the spirit of good sportsmanship, will use good judgment in abiding by the intent of these rules. For administration info, see club bylaws.

TABLE OF CONTENTS

CHAPTER	TITLE	PAGE
I	Construction	3
II	Weapons	14
III	Special Structures	19
IV	Speed	20
V	Safety	21
VI	Certification	24
VII	Combat Rules	25
VIII	Scoring	30
IX	Grandfather Clause	36
X	New Technology	38
6APPENDIX A	Changes in the Rulebook for 2011 - 2016	39
APPENDIX B	Aircraft Gun Barrel Placement Illustration and Notes	40
APPENDIX C	Voting Rules	41

TABLE OF CHARTS AND FIGURES

CHARTS/ILLUSTRATIONS	SUBJECT	PAGE
Figure 1	Armor Thickness Table	6
Figure 2	"60 Degree Rule"	6
Figure 3a – 3b	Frame and Penetrable Windows	9
Figure 4	Illustration – Definition of Main Deck	11
Figure 5	Gun Calibers, Rate of Fire	14
Figure 6	Torpedo Tube Spacing	14
Figure 7a –7b	Armament and Pump Charts	17
Figure 8	Time/Speed Conversion Chart	20
Figure 9	Damage Assessment Chart	29
Figure 10	Sink Scoring Chart	29
Figure 11	Other Scoring Values	31
Figure 12	Convoy Scoring Chart (by vessel length)	32
Figure 13	Sortie Combat Points	32
Figure 14	Captain's Choice Combat Points	32
Figure 15	Maneuvering and Gunnery Points	33
Figure 16	Service Points	33
Figure 17	Ranking Chart	34
Figure 17-a	Event Director Advancement Chart	34
Figure 18	Current Grandfathered Vessels	37

CHAPTER I – CONSTRUCTION

A. DESIGN GUIDELINES

1. Definitions

- a) Launched (i.e. “Historic” or “Real”) ships are defined as ships that were launched and commissioned into service, or launched but not completed.
- b) Non-launched ships are defined as either laid down but not launched, or never laid down.

2. General Reference Sources

The following documents shall hereinafter be referred to as **Conway’s**. Conway’s will always be considered the prime reference for ship data, and ships that are not clearly defined in Conway’s are not allowed into competition in any club event. (Exception: All ship classes specifically noted in CHAPTER X - GRANDFATHER CLAUSE and convoy vessels.)

- a) *Conway’s All The World’s Fighting Ships 1860-1905*
- b) *Conway’s All The World’s Fighting Ships 1906-1921*
- c) *Conway’s All The World’s Fighting Ships 1922-1946*
- d) *Conway’s All the World’s Battleships 1906 to Present*
- e) *Conway’s Battleships: The Definitive Visual Reference to the World’s All-Big-Gun Ships*

For Launched ships only: If a builder believes Conway’s is in error regarding a particular specification, or has omitted specific information that has a direct bearing on the construction or outfitting of a given model, Conway’s may be challenged on those specific points as follows:

- a) A minimum of two other sources must be obtained (copies or extracts are acceptable)
- b) Both sources must agree in the deviation from Conway’s specifications or notations
- c) The club’s officers may disregard this source information if the sources are in doubt

3. Eligibility for Combat

All ships eligible for combat must have all of the following key statistics listed in the data table format in its Conway’s entry:

- a) Length
- b) Beam
- c) Displacement

- d) Main armor belt thickness
- e) Armament
- f) Maximum speed

Non-launched ships must be built according to the statistical data listed in the data table only, and cannot be built to any alternate design statistics listed in the accompanying descriptive paragraphs. Non-launched ships missing any of the above key data in the data table cannot be built. Non-launched ships cannot be built to any non-Conway's data, even if there are two or more alternate sources with data that match. Exceptions: See [Chapter IX – Grandfather Clause \(Waivers\)](#).

Note: Preliminary and non-launched versions of launched ships, as noted in the accompanying Conway's paragraphs, are not eligible for combat.

Plans or drawings used to build ship models shall be reasonable to design concepts of the era, must be backed by copies of original sketches, and must be presented to and approved by 2 senior club officers. A copy of the plans and approvals must be provided to the club secretary.

4. Best of Class

If a vessel is part of a class, it may have the best characteristics or traits of any launched ship in that class as described in Conway's. The Best of Class allowance does not apply to non-launched ships.

5. Historical Period

Only scale ship models of vessels that were accepted designs by any Navy between the calendar years of 1900 and 1946, and meet the requirements of the *General Reference Sources* described above may compete in club events. Accepted designs are defined as ships in service and/or ships with specifications noted in the Conway's data tables. Sailing ships and hybrid ships (ships that were built to be of dual purpose such as a combination battleship/aircraft carrier) are not allowed to compete in club events.

6. Convoy Vessels

A convoy vessel is any ship whose primary function was the delivery of troops, war materials or goods. This includes transport ships of all types, plus fleet service ships and auxiliaries, such as oilers and repair ships. Ships that only as a special circumstance delivered such goods shall not be considered convoy vessels.

All convoy vessels shall travel at a maximum of 25 knots. These ships are given numerous special

allowances in order to increase their survivability and keep them competitive:

- May be armed if the prototype was so equipped
- May be repaired at any time provided they are in their home port
- May be removed from, and returned to, the water at any time provided they are in their home port
- May stay in their home ports as long as their captains' wish
- May ram any other vessel
- Score points against the other team for each completed lap of a designated course, the number of points scored to be based on length of the convoy vessel. (A lap is defined by the Combat Director prior to the sortie.) [See Cargo Points.](#)
- May have two watertight bulkheads ([See Chapter I Construction, Section D Hull Internal Structure Guidelines, # 2\) Watertight Compartments](#))

7. Scale Appearance

All vessels must be built to 1/144 scale (1" = 12') +/- 5%. WWCC has earned a reputation for detailed scale modeling excellence in our combat vessels. To promote and maintain this tradition, a "Best Detailed Ship" prize will be awarded at every combat event to the skipper with the best scale details on their ship. Popular voting by all skippers attending the event will determine the winner for that combat event. Winning skipper earns two bonus combat points for the award.

Standards to be considered when voting for "Best Detailed Ship" should be as follows:

- All funnels and superstructure features over one cubic inch present as represented on the plans.
- All barbets and turrets for primary and secondary turrets (If present on the plans) will be represented on the ship at the start of a sortie or campaign game.
- Mainmast as represented on plans Armament

B. MATERIALS

1. Construction Materials

Shipbuilders have two options of materials for covering the penetrable areas of the hull:

Option A) Balsa Wood

Balsa wood may be used on the penetrable part of the hull from 3/8" below the top of the main deck to a point 1" below the water line. Use Figure 1 Armor Thickness Table below to determine the thickness of the balsa wood. No lamination of balsa in this penetrable area is permitted. The remainder of the ship can be made of any material. One exception is the use of materials that would

add unreasonable amounts of buoyancy as judged by the Technical Officer and / or Club senior officers. From 1" below the waterline to the bottom of the keel, any material may be used. (See figures 3-a through 3-d)

Option B) Duct and Aluminum Tape

For ease of construction, the builder may opt to use 1 layer of duct tape plus 1 layer of aluminum based tape, instead of balsa wood, to cover the penetrable part of the hull from 3/8" below the top of the main deck to a point 1" below the water line. Unroll the duct tape and apply lengthwise horizontally to the hull from bow to stern to cover the penetrable areas. If the duct tape is too narrow to cover the entire height of the penetrable area with one strip, **an overlap of no more than ½ inch of tape is allowed** when applying an additional strip of tape.

To prevent flexible flaps and tears from self-sealing a bb-punctured hole, a single layer of aluminum tape is required.. The aluminum tape may be applied either as a layer underneath the duct tape, or above it as the top layer, at the builders discretion. NOTE: if aluminum tape is applied underneath the duct tape directly to the hull, it is very difficult to remove for maintenance, so the builders must choose this option at their discretion.

All ships must be painted as per prototype to allow the correct scoring of holes in the grey/camouflaged above-water part of the hull, on the boot line as per prototype, and in the red submerged part of the hull. If the aluminum tape is on top, it must be painted per prototype (no different than balsa built ships.) If the aluminum tape is underneath and duct tape is the outer layer, then painting is optional if using grey and red duct tape for the above water and under water parts of the hull, with black masking or hobby striping tape as the boot topping. NOTE: In the absence of a black boot topping, any waterline hit is scored as a RED hit.

If a ship has its entire duct tape hull skin replaced in between sorties at pond side, then the grey and red painting may be deferred until the next event, but the waterline or boot topping must be temporarily marked with paint or black masking or hobby striping tape to allow scoring.

Some recommended brands of duct tape:

National Brand Duct Tape

Scotch 3M Red USA

Black 3M

Red Scotch 3M Canada

2. Penetrability

For scoring purposes, all ship models and shore gun emplacements must have penetrable hulls, defined vertically from 3/8" below the top of the main deck to a point 1" below the waterline, and defined horizontally by the width of penetrable "windows" in the hull, according to the standards set in figures 3-a through 3-d. Radio gear and other equipment may be protected from combat damage by the installation of internal blast shields, as long as hull penetrability is not affected.

When using Option A – balsa wood construction, the allowable thickness of the penetrable area of the ship model's hull shall correspond to the actual armor thickness of the model's prototype, per Figure 1, and is based upon the thickest part of the given prototype ship's belt armor.

ARMOR THICKNESS	BALSA WOOD THICKNESS
0" to 2.99"	1/16"
3" to 11.99"	3/32"
12"+	1/8"

Figure 1 Armor Thickness Table

When using Option B – duct tape and aluminum tape construction, the scale armor thickness in the figure above does not apply – all duct-taped ships get 1 single layer of duct tape and 1 layer of aluminum tape regardless of the thickness of the prototype ship's armor. Builders who opt for using the duct tape option should note that extensive R&D testing demonstrated that the tape option confers no comparable protective qualities and they should choose this option only for ease of construction and maintenance. The builder must be aware of and accept that duct tape may be inferior to balsa of any thickness in terms of protection against bb penetration.

3. 60-Degree Rule

As described above, the hull must be penetrable to 1 inch below the waterline. However in cases where the hull dimensions provide less than one inch of height below the waterline (for example, typically in the shallow stern area between the waterline and propeller shafts), establish the lower edge of the minimum penetrable area by finding the point at which the longest side of a 60-degree or less triangle touches the bilge curve of the hull.

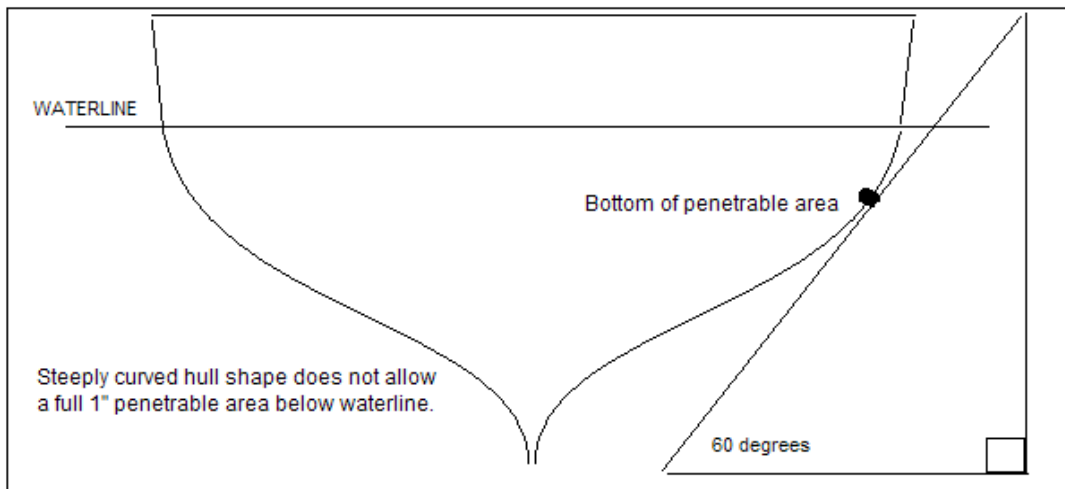

Fig. 2 "60 Degree Rule" Illustration

If even after applying the 60-degree rule the hull shape and dimensions allow insufficient impenetrable area to securely mount the stuffing tubes, the impenetrable area around the tube exit points may be extended by 1/2 inch above the top edge of the stuffing tube, but must not exceed 1.5 inches in length.

4. Finishing Materials

- a) For balsa wood construction only: one layer of lightweight silk span (0000) is allowed on the inside and outside of the hull.
- b) All paint used must be lacquer or water based from a point measured up from 1" below the water line.
- c) Epoxy, enamel and house type latex paints may not be used.
- d) Fillers shall not be used to add to the strength of the balsa wood.

5. Repair Materials

Temporary repairs of battle damage to the hull may be made after scoring. One layer of masking tape, applied to the "damaged" section of hull may be used to make the hull watertight. This is applicable to both balsa and tape built hulls. All ships must be repaired prior to the next scheduled battle day. (This rule applies specifically to penetrations in the hull; however, members are encouraged to maintain ship-shape appearance.)

C. HULL GENERAL CONSTRUCTION GUIDELINES

1. Waterline and Boot Toppings

- Shall be exact as per ships drawing.
- A fully loaded model shall not ride lower than the top of the boot.
- The top of the boot must correspond to the actual full load waterline as per the plans.
- Boot toppings may be painted on or applied with tape, and shall have a maximum width of 1/2".
- The nominal waterline shall be centered to the boot topping.

2. Hull Dimensions

- Hull dimensions shall conform to the scale of the prototype, except as follows.
- An additional 1" of hull depth, over the ship's plan, is allowed.
- A ballast strip not to exceed 3/8" of thickness may be applied to the bottom of the ship.
- The waterline relative to the top of the deck, as defined by the ship's drawings, shall not change.
- This is a total allowance of 1³/₈" below the keel, as defined by the ship's drawings. No other allowances are permitted.

3. Frames and Penetrable Windows

- Frames may be spaced 1" apart, measured from the two inside edges of the penetrable window, for every 1/8" of frame thickness. For example:
 - 1/8" thick frames shall be at least 1" apart.
 - 1/4" thick frames shall be at least 2" apart.
 - 3/8" thick frames shall be at least 3" apart.
- The impenetrable areas of the bow and stern of the ship shall extend a maximum of two inches toward amidships as measured at the waterline.
- Builder may opt to mix different frame thicknesses and frame separation within the same hull. Builders may choose only the three frame thicknesses listed above. If a hull has mixed frame thicknesses, any penetrable window formed by a thicker frame on one side and a thinner frame on the other side, must use the frame separation allowed for the thicker frame.

For example, if a penetrable window is formed by a 1/8" thick frame on one edge, and a 3/8" frame on the other edge, the penetrable window must be three inches wide when measured from inside edges of the two frames.

Under no condition shall frames exceed 3/8" in width. A solid area of no more than 3/8" between the top of the deck and the top of the penetrable windows is permitted. (Reference figures 3-a through 3-d)

- **Note:** Fiberglass hulls must follow the same rules as wooden framed ships. Windows are cut into the fiberglass hull and then covered in balsa wood or duct tape + aluminum tape. The width and height of the windows and surrounding frames are subject to the same rules as wooden ships. The impenetrable areas of the bow and stern of the ship shall extend a maximum of two inches toward amidships as measured at the waterline.

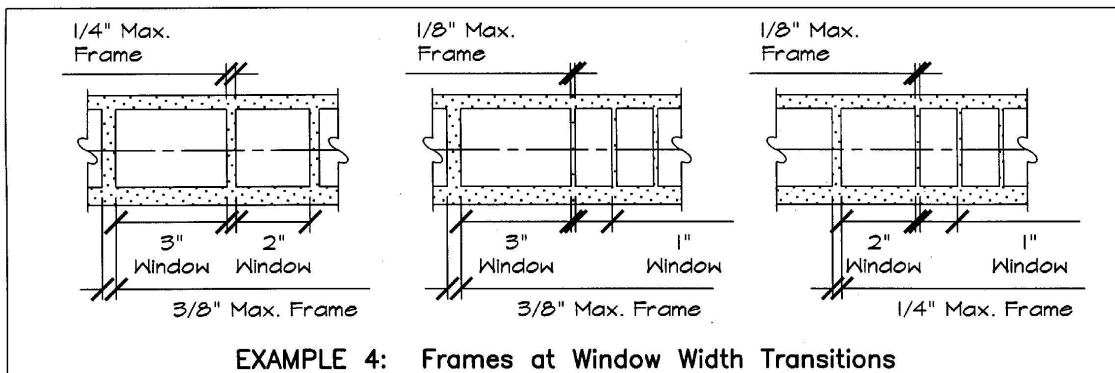
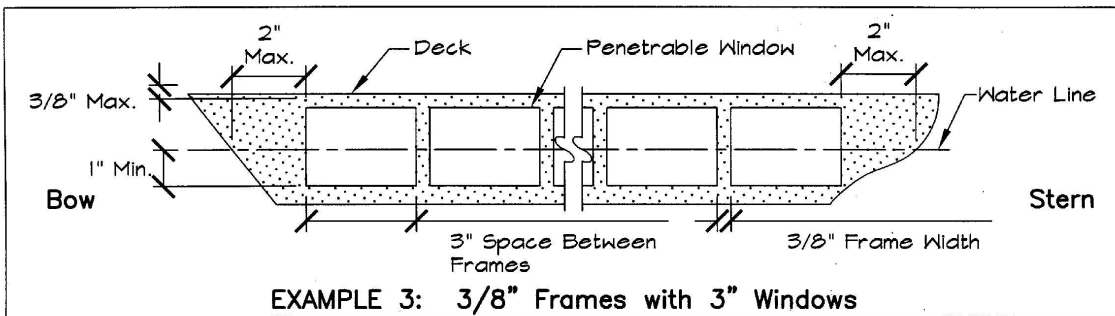
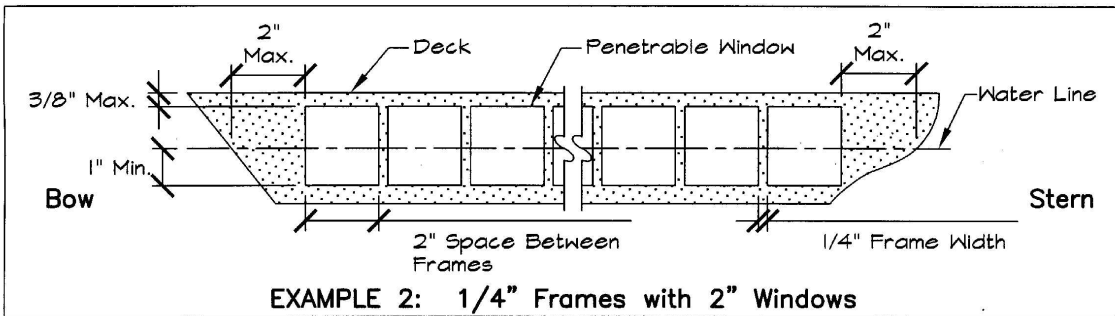
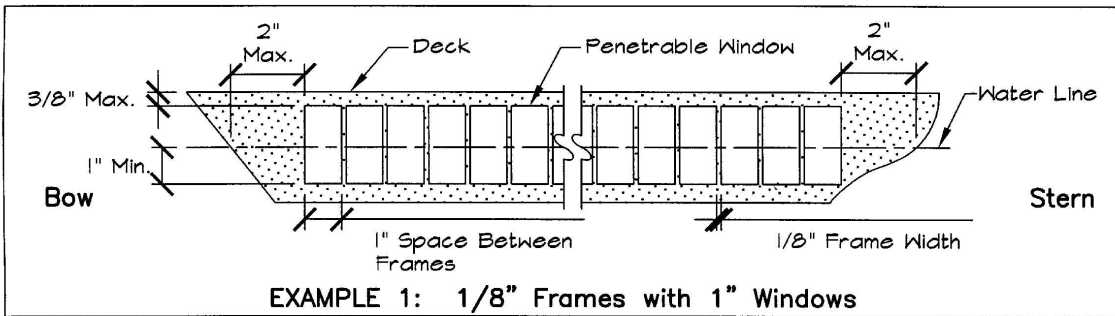

HULL FRAME AND PENETRABLE WINDOW ILLUSTRATIONS

Figure 3a – 3d – Frames and Penetrable Window Illustrations

4. External Armor Belt Line

- For ships with a visible upper edge of the external armor belt (for example Bismarck), the following special construction is allowed.
- Fiberglass hulls: A 1/8" wide horizontal fiberglass stringer or strip may be left in the hull by cutting a small upper window above this stringer, and a taller lower window below the stringer. The builder may use this non-penetrable fiberglass stringer to support the upper edge of the external armor belt.
- Wooden hulls: a 1/8" wide horizontal lamination of wood is allowed to create the effect of the upper edge of the external armor belt.
- Both the fiberglass stringer and the wood lamination are restricted to the horizontal length of the visible external armor belt. The stringer or lamination cannot be carried to the bow or stern where there is no visible upper edge of the armor belt. These cannot be placed at the waterline, only on the prototype location of the upper edge of the visible armor belt.

5. Definition of Main Deck

- Unless noted otherwise, the Main Deck is the lowest exposed deck at the ship's perimeter. The Main Deck may locally occur at more than one elevation for ships with stepped decks.
- The main deck of ships converted to aircraft carriers shall match the main deck location of the original ship or the lowest exposed deck at the aircraft carrier's perimeter, whichever is locally lowest.
- For ships originally built as aircraft carriers and as an alternate for ships converted to aircraft carriers, the main deck shall be the hanger deck or the lowest exposed deck at the aircraft carrier's perimeter, whichever is locally lowest.
- For ships with casemate guns and gun platforms beneath the main deck: The casemate guns/ platforms may be impenetrable. A 3/8" maximum area beneath and adjacent to the casemate guns/ gun platforms may be impenetrable. Closely spaced casemate guns may have impenetrable area between the guns. Casemate guns spaced 4-inches or greater center-to-center shall have penetrable area between the casemate guns. Frames may occur in the penetrable area between casemate guns. The penetrable area adjacent to casemate guns and gun platforms may be less than shown on Figure 3 provided that the frames and windows meet the Figure 3 requirements beneath the casemate guns.

Examples of Main Deck, and Impenetrability at Casement Guns/Gun platforms

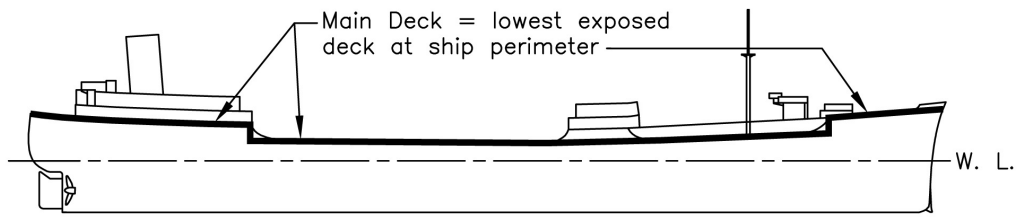

Main Deck Example of Ship With Stepped Decks

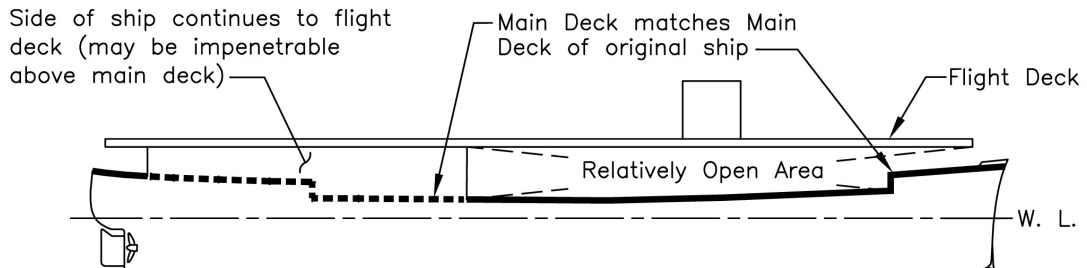

Main Deck Example of Aircraft Carrier Converted from Another Ship

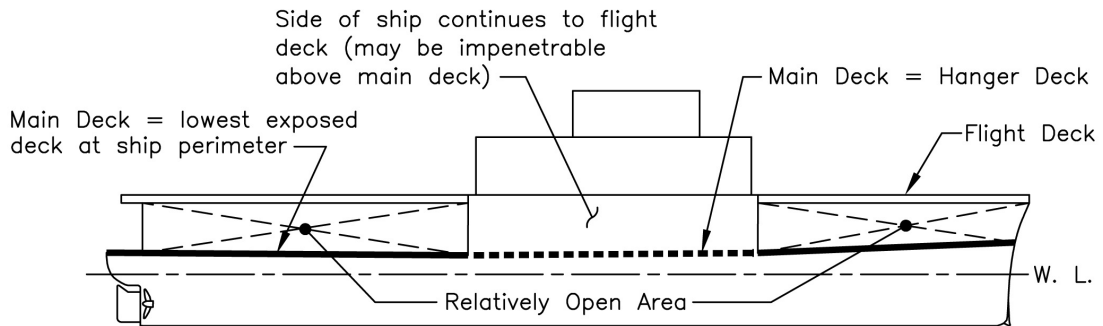

Main Deck Example of Aircraft Carrier

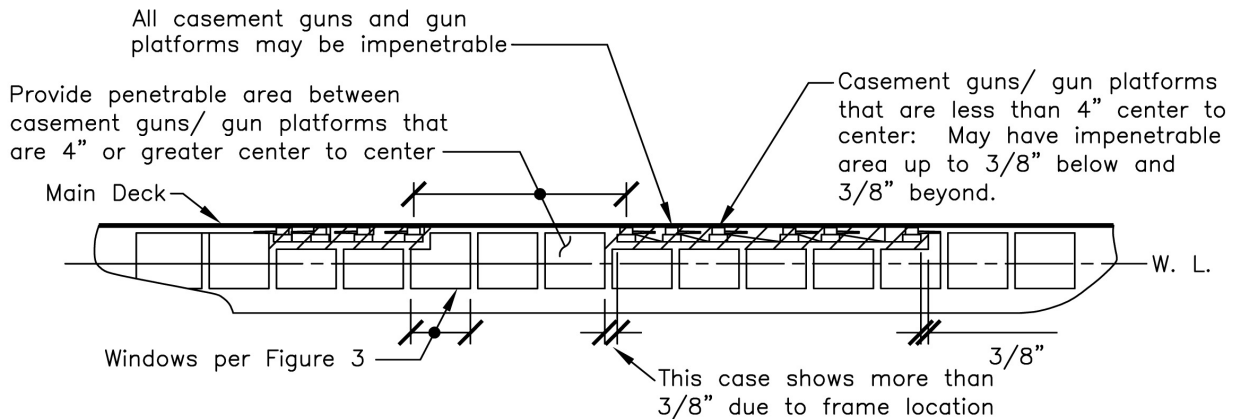

Impenetrable Area Example of Ship With Casement Guns

Figure 4: Illustration, Definition of Main Deck

D. HULL INTERNAL CONSTRUCTION GUIDELINES

1. Waterproof Containers

Radio gear, motors and speed controls may be installed in one or more watertight boxes or containers, as long as these containers are not large enough to help keep the ship afloat.

2. Watertight Compartments

In general, water must be able to flow freely within the hull, from bow to stern. Bulkheads that divide the ship model's hull into compartments that prevent the free flow of water in the hull are not allowed, with two exceptions.

- Combat vessels whose prototypes had a standard displacement of less than 15,000 tons are allowed one single watertight bulkhead, extending from the bottom of the hull to any height, up to and including the deck. This bulkhead may be placed anywhere within the hull. In all other cases, water must be free to flow from bow to stern.
- Convoy vessels are allowed up to two such bulkheads placed anywhere within the hull. [See Chapter I Construction, A:Design Guidelines, # 6: Convoy Vessels](#)

Note: installation of bulkheads cannot lessen penetrable area.

3. Water Channeling

Water Channels are defined as any structure inside the hull used for directing water entering the hull towards pumps. Any water channeling structure must not exceed a half-inch in height as measured from the bottom of the water channel, i.e. water must freely overflow the channel at a point 1/2" above its bottom IN ALL DIRECTIONS. (For example, if using the blast shield as a water channel, holes, or cutouts with a *maximum* of 1" separation between them must be drilled in the blast shield at a point 1/2" above the bottom of the water channel to allow water to freely overflow the side of the water channel, as well and forward and aft).

Metal or plastic tubing may be used as water channel between watertight bulkheads, if the vessel has them (*see, Watertight Compartments, above*). Any tubing(s) used as water channel must not exceed 1/2" inside diameter in total, between bulkheads or between bulkhead and pump.

4. Listing Devices

Remote-controlled list control devices are permitted.

E. STEERING AND PROPULSION CONSTRUCTION GUIDELINES

1. Rudders

- Rudders may be made out of any material.
- Rudders for warships may be 25% larger by area.
- Rudders for convoy vessels may be 100% oversize.
- Rudders must be in the proper position and proper shape.
- Rudders must be of the same quantity as on the prototype.
- Submarine dive planes may be twice the area shown on their plans.

2. Propulsion

- Only electric motors may be used.
- Propellers may be 50% larger in area.
- Not all propellers (or their shafts) must be present, but those present must be in the proper position.
- Bow Thrusters are allowed only if the prototype had them.
- No vessel may have more propellers or thrusters than the prototype.

3. Weed Guards

Weed guards are allowed.

4. Pumps

All surface vessels are allowed at least one flood control pump. The pump may be automatic or manually controlled, but while the club does not restrict the number of pumps, the number of outlets and outlet diameters are determined by displacement. (See the [Pump and Armament charts, figures 6-a through 6-b.](#))

CHAPTER II – WEAPONS

A. GUN SPECIFICATIONS

- Guns (including “torpedo guns”) shall be in the same location as shown on the plans.
- Gun barrels (including “torpedo guns”) must be within 1/2” of scale height as measured from the main deck to the top of the barrel.
- Barrel lengths shall not exceed 6” long measured from the center of the bend to the muzzle
- Gun barrels must be within 1” of scale length as measured from the front of the turret face or as per the plans.
- Torpedo barrels may not extend more than 1/2” horizontally beyond the hull of the ship

ALLOWABLE SIZES OF BALL BEARINGS ARE BASED ON PROTOTYPE ARMAMENT

PROTOTYPE SHELL SIZE	BALL BEARING SIZE	MAXIMUM RATE OF FIRE
3" to 7.99"	BB	once every 4 seconds
8" to 10.99"	3/16"	once every 4 seconds
11" to 14.99"	7/32"	once every 6 seconds
15" to 20"+ (includes 380mm)	1/4"	once every 8 seconds
Torpedoes (all)	Optional (max 1/4")	once every 30 seconds

Fig. 5 Gun Caliber to Ball Bearing Size Conversions, Rate of Fire

B. TORPEDO SPECIFICATIONS

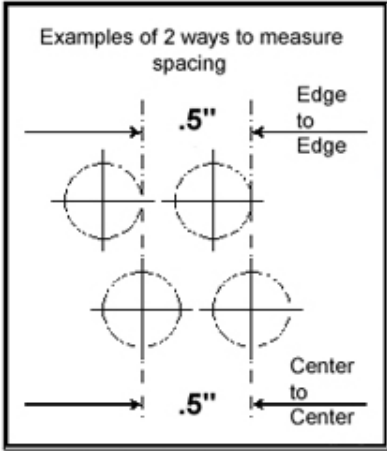

Torpedo Barrel Spacing

Torpedo launchers must be installed in the scale location per the prototype.

Torpedoes may be any caliber up to and including 1/4" ball bearings

A maximum of 6 torpedo guns are allowed, split 3 port, 3 starboard. No more than 3 torpedo tubes may be grouped together.

Except in the case of single barrel multi-ball torpedo cannon, only one ball may be fired at a time from any torpedo barrel.

Individual groups or mounts of torpedoes, port, starboard or rotating must have at least a 90 degree angle of separation in the directions they fire their torpedoes, excluding submarines.

Fig. 6 Torpedo Barrel Spacing

Torpedoes can be separated into two main types: reloading and non-reloading (single-shot). Each has its advantages and disadvantages, both mechanically and in game play, and each can be used in a variety of configurations. (See below). It is highly recommended that you consider the pros and cons of each, prior to making a choice for your particular application, and when in doubt: speak with a tech officer.

Reloading torpedoes

- Are allowed a maximum capacity of 30 rounds total per vessel regardless of number of tubes.
- These rounds may be divided and distributed in magazines in any combination.

Non-reloading torpedoes

Ships or submarines may be armed with single-shot torpedoes and reloaded by returning to port, per the port rules for any given sortie or campaign game. [See Chapter VII - Combat - Port Rules](#)

1. Centerline rotating mount

May be represented with reloading or non-reloading fixed barrels as follows:

- One tube per side if the prototype mount consisted of one tube or more, **OR**
- Two tubes per side if the prototype mount consisted of two tubes or more, **OR**
- Three tubes per side if the prototype mount consisted of three tubes or more, **AND**
- The prototype ship had the required number of tubes overall to qualify for such.

2. Single barrel multi-ball torpedo cannon

- Replaces a prototypical multi-barrel torpedo mount in surface vessels or submarines
- May fire up to three rounds per shot (one round for each torpedo tube per the prototype)
- May be reloading or non-reloading

3. Underwater torpedoes (surface vessels only)

Underwater torpedoes, per the prototype, are allowed under the following conditions:

- Must be mounted at least 1/4" above the waterline and no more than 1" above the waterline.
- Where a torpedo gun penetrates the hull, through a normally penetrable area, no additional reinforcement is allowed.
- May be reloading or non-reloading

4. Submarine torpedoes

- Submarines are allowed the use of fabricated torpedoes (3/4" tube soldered to 1/4" ball bearing) or a .24" bullet, and may be reloading or non-reloading.

Securing Torpedo Rounds (Wadding)

Grease, Vaseline, margarine or other products that leave a non-water soluble residue may not be used as wadding to hold in torpedoes, because these materials transfer to the hull and superstructure of the target ship, preventing masking tape from sticking to the affected areas. Suggested methods of securing torpedo balls include, but are not limited to, the following.

- Paper, silk span, cloth or other biodegradable, non-greasy wadding
- Magnet
- Tape over the mouth of the barrel. (Fire through the tape.)

C. DEPTH CHARGES

Depth charges may be simulated by a single barrel gun as follows::

- Any vessel that dropped depth charges may carry one working depth charge gun.
- This gun may be any caliber, up to and including 1/4".
- The barrel is mounted through the hull to fire down on submarines.

D. MINES

A minefield may be constructed and deployed only as follows:

- 1 minefield may be deployed for the defense of each shore battery. ([See ch. IV section A](#))
- A minefield will be made of no greater than 6 lb. test fishing line.
- The length of line floating on the surface shall be no longer than 10 feet. This does not include the anchoring length.
- Flotation devices may be attached to the line.
- Flotation devices shall have a 1-foot minimum spacing between them.
- The line shall be weighted at both ends with a 2 ounce oval or rounded weight.
- The individual deploying the mines is responsible for their recovery after the sortie.
- Mine fields may not be removed from an entangled ship during a regular sortie.
- Mine fields may be removed from an entangled ship at any time during a campaign game provide that the skipper or team mates is able to successfully return the crippled ship to its home port.

E. AIRPLANES

- Only aircraft carriers may launch airplanes for scoring points (See fig. 8).
- May be made of plastic or balsa, approx. 2 oz.
- Must launch from prototype locations on the carrier, using a maximum of two catapults.
- May be launched via compressed air, HPA, CO2 or spring.

- Each catapult must be fired independently.
- Catapults may be reloaded during a sortie or campaign game, but only after all loaded catapults carried by the vessel have been fired.
- Reloading must be done in home port in one minute or less, and the vessel may not be taken from the water to reload.
- If a launched aircraft strikes and penetrates the hull of a targeted vessel (friend or foe), the ensuing hole shall be scored by the same rules as any other battle damage is scored, in addition to the 20 points that the airplane is awarded for merely striking an enemy vessel. ([See fig. 8 in scoring section](#)).
- The owner of a launched airplane is required to retrieve it from the pond, prior to the start of the next sortie or campaign game period.

F. ARMAMENT AND PUMP OUTLET ALLOWANCES

Note: Number of pumps is up to the skipper. Number of outlets is limited (see chart below)

AIRCRAFT CARRIERS

STANDARD DISPLACEMENT	ROTATING GUNS	GUNS	Additional Small GUNS	TORPEDOES	PUMP OUTLETS & I.D.
45,001 TONS AND OVER	NO	20 x 1/4" no more than 50% on one side	4 X 3/16"	NO	*2 X 1/4"
45,000 TO 20,000 TONS	NO	16 x 1/4" no more than 50% on one side	4 X 3/16"	NO	2 x 1/4"
UNDER 20,000 TONS	NO	12 x 1/4" no more than 50% on one side	4 X 3/16"	NO	1 x 1/4"

Fig 7-a Armament and Pump Allocation Chart: Aircraft Carriers

Figure 7-a Notes:

- *The Japanese carrier **Shinano**, and **only** that **carrier**, may have three pump outlets, each with 1/4" inside diameter.
- Aircraft carriers shall mount all guns and barrels in fixed positions beneath the flight deck. Guns may have remotely adjustable depression. Guns may be any caliber up to and including 1/4-inch. Additional small gun sizes and allowance shall be per the table. No more than 50% of the carrier's allotted guns, can be aimed within any 180° field of fire, [see Appendix B](#). The additional small guns (4 x 3/16") are not part of the "50% of guns within a 180° field of fire rule," and can be placed anywhere under the flight deck of the carrier.
- The rate of fire for all aircraft carrier guns shall be in accordance with [Fig. 5: Gun Caliber to Ball Bearing Size Conversions, Rate of Fire](#).
- The rate of fire for launching aircraft shall be 30-seconds minimum per catapult.

SURFACE VESSELS AND SUBMARINES

STANDARD DISPLACEMENT	ROTATING GUNS	GUNS	TORPEDOES (AS PER PROTOTYPE)	PUMP OUTLETS & I.D.
WARSHIPS OVER 50,000 TONS	YES	ALL OVER 3" (75MM)	MAXIMUM 3 PER SIDE	3 x 1/4"
WARSHIPS 50,000 TONS TO 20,000 TONS	YES	ALL OVER 3" (75MM)	MAXIMUM 3 PER SIDE	2 x 1/4"
WARSHIPS UNDER 20,000 TONS	YES	ALL OVER 3" (75MM)	MAXIMUM 3 PER SIDE	1 x 1/4"
SUBMARINES	YES	ALL OVER 3" (75MM)	MAXIMUM 4	1 x 1/4"
CONVOY VESSELS	YES	ALL OVER 3" (75MM)	MAXIMUM 3 PER SIDE	1 x 1/4"

Fig 7-b Armament and Pump Allocation Chart: Surface Vessels and Submarines

CHAPTER III – SPECIAL STRUCTURES

A. SHORE BATTERIES

Shore batteries are used for protecting docks from bombardment by enemy vessels and may not be run without a dock.

- Dimensions: 12" x 12", with 3/16" balsa armor.
- "Boot" marking at waterline: 1/4" minimum width, 1/2" maximum width
- Penetrable area shall be a 10" long strip, 1" below waterline and 1" above
- The maximum freeboard shall be 2", with at least 6" of water depth under the bottom
- May have one standard pump, 1/4" sized outlet
- The number and caliber of barrels installed in shore batteries shall be representative of actual shore batteries used from 1900 to 1946, and conform to the current rules for ship guns (.177" to 1/4", with 6" maximum barrel length measured from the center of the bend). Ex: Germany installed a Gneisenau triple-barrel turret as a shore battery in Norway. A model of this battery could have three 7/32" barrels.
- Placement: Must be placed within 10' of the dock it is meant to protect and within 10' of the port it meant to defend.
- Operation: Operators must remain at least 5 ft. away from shore battery.
- Defensive Mines: The shore battery operator may place one 10' string of defensive mines weighted at both ends within a 10-ft. radius of the battery. (See chapter 3 section D)

B. DOCKS

- Dimensions: approximately 6' x 1'. The thickness does not matter, but max freeboard is 1"
- Docks shall be equipped w/10 items/targets, any material or shape, with at least 4 sq. in. of target area each (e.g. 2" foam cube), but must indicate hits by falling off or getting knocked over when hit.

CHAPTER IV - SPEED

All vessels, except vessels whose prototypes operated at less than 25 knots actual speed, shall run at scale speed. Any vessel whose prototype had a top speed of less than 25 knots may run at 25 knots in scale speed (*see speed/time & radar chart below*). Convoy vessels shall run at 25 knots even if the actual speed of the prototype vessel is greater than 25 knots.

A. SPEED CONTROL RESTRICTIONS

- All motors capable of turning a pre-op for propulsion must be set so that they shall not increase RPM in a turn.
- Radios shall not be set up to allow an increase in RPM over and above that used to set the scale speed in a straight line nor shall additional props be brought on line remotely.
- A timed throttle system that enables props to exceed their RPM used to set the scale speed in a straight line is illegal.

B. SPEED CHART

Fig. 8 shows the 1/144th scale speed of a vessel in seconds over 100 feet, as well as corresponding radar readings:

SPD	SEC	RAD	SPD	SEC	RAD	SPD	SEC	RAD	SPD	SEC	RAD
20	56.25		30	37.50	1.59	40	28.13	2.12	50	22.50	2.64
21	53.57		31	36.29	1.64	41	27.44	2.17	51	22.06	2.70
22	51.14		32	35.16	1.70	42	26.79	2.23	52	21.63	2.75
23	48.91		33	34.09	1.75	43	26.16	2.28	53	21.23	2.80
24	46.88		34	33.09	1.80	44	25.57	2.33	54	20.83	2.86
25	45.00	1.33	35	32.14	1.86	45	25.00	2.39	55	20.45	2.91
26	43.27	1.38	36	31.25	1.90	46	24.46	2.44	56	20.09	2.96
27	41.67	1.43	37	30.41	1.96	47	23.94	2.49	57	19.74	3.01
28	40.18	1.48	38	29.61	2.01	48	23.44	2.54	58	19.40	3.06
29	38.79	1.54	39	28.85	2.07	49	22.96	2.59	59	19.07	3.11

Fig. 8 Time/Speed Conversion Chart

CHAPTER V – SAFETY

ALL MEMBERS AND PARTICIPANTS MUST ADHERE TO SAFETY RULES

A. SYSTEM SAFETY

1. Air systems:

- All fittings and hoses must be properly pressure rated.
- All vessels must have an onboard on/off airflow switch (toggle), *or* all barrels must have gun pins.
- Maximum air pressure shall not exceed 150 PSI at the gun tank.
- Air tanks must be rated at least 1-1/2 times higher than the operating pressure.
- All gas control systems must be easily accessible.
- All air sources shall have a regulator pressure control for charging boat accumulators.

If, in the opinion of the Technical Officer or Safety Officer, a system is unsafe, then the system will not be pressurized until such repairs have been made and the system is inspected and deemed safe.

2. Regulators:

- Pressure Relief Regulators must be set to not more than 150 PSI.

3. High-pressure tanks and hoses:

- High-pressure tanks, lines and valves are those operated in excess of 300 PSI.
- All high-pressure tanks and bottles larger than 2” in diameter are to be hydrostatically tested as per the code stamped into the side.
- The date of test and PSI rating must be stamped on all high-pressure tanks and bottles.
- At NO time shall a tank or bottle be pressurized above the stamped PSI rating on the tank.
- A tank intended to supply gas, receive gas and the associated valves and lines shall be of a type and designed and engineered for that particular gas.
- No high-pressure line or valve shall be used above its rated pressure.

4. Gas for systems:

Only compressed air (supplied by an air compressor), HPA (including pure nitrogen), or CO₂ may be used.

5. High Pressure Air (HPA)

There are currently 2 types of HPA/Nitrogen tanks available: all-metal and composite (fiber) wrapped. Both types are approved by DOT, the federal agency that regulates the storage and transportation of the gases we use.

- a) All-metal tanks (commonly made of aluminum) are rated up to 3,000 PSI operating pressure, and are currently allowed in WWCC events.
- b) Composite-wrapped tanks are rated up to 4,500 PSI operating pressure, and are currently not allowed in WWCC events.

6. Filling Procedures

- Filling of high-pressure tanks shall be conducted in an area specified by the Safety Officer.
- In the absence of the Safety Officer, the authority for designating a filling area shall rest with the event director.
- Members utilizing high-pressure tanks for the purpose of dispensing gas to an additional tank shall do so as described below:
 - a) The transferring of HPA or CO₂ shall be done in the designated area
 - b) A tank intended to supply gas, receive gas and the associated valves and lines shall be of a type and design suitable for such high-pressure gas.
 - c) Upon the completion of transferring gas, each tank valve shall be closed and any gas pressure remaining in the transfer line shall be released.

7. Gun Systems

- All barrels shall be pinned or capped at all times when the ship is out of the water and must be put in place before the vessel is removed from the water, "OR" there must be an air release switch that shall be easily accessible to turn off and bleed gas from the guns.
- No positive elevation of gun barrels is allowed.
- The muzzle velocity of any main gun shall not penetrate through 2" thickness of target foam at a distance of 1 foot from the end of the barrel.

8. Inspections

- The Safety Officer or Technical Officer shall inspect the ships to insure the ships are within guidelines.
- Guns will be tested in the presence of the Technical Officer for certification and at any time he feels a recheck is necessary, in his judgment.

- If the Technical Officer or Safety Officer declares a system unsafe, the vessel will NOT be put in the water until the necessary repairs have been made or the discrepancy resolved.

B. EVENT SAFETY

1. Test Firing

- Unauthorized shooting out of the pond is not permitted.
- Test firing guns from shore shall be done in an area designated by the Safety Officer.
- All rounds will be fired into the pond.
- Shooting from the pond will not be permitted until the event starts.

2. Pit Area

- The pit area is the area defined by ropes and stanchions.
- Spectators are not allowed in this area during battle!
- The Event Director and every club member shall police the pit area, and rope it off, if necessary, to control public access to the pit area. Behavior that violates NAMBA insurance or SCVWD/city rules covering pond usage is prohibited.

3. Pond

- No one may enter the pond for any reason until the "cease fire" is given.
- Cameramen may enter the water if they are wearing full head and face protection, such as a helmet and face shield.
- All persons at or near water's edge shall wear eye protection while guns are being fired.
- Safety is an all-hands effort and spectators will be held at a distance of 15-ft minimum from the edge of the pit area. All participants are expected to police themselves accordingly, in or out of the pit area.

CHAPTER VI – CERTIFICATION

A. AUTHORITY

- The Technical Officer (T.O.) shall certify vessels.
- At the direction of the C.O., the Safety Officer may certify a vessel in the absence of the T.O.
- The certifying officer will inspect the vessel to insure compliance with the following:
 - 1) Meets all safety requirements.
 - 2) On board air toggle switch to bleed off air and prevent accidental firing.
 - 3) Meets all construction standards (ref, Section II).
 - 4) The vessel shall be built to stand off scale plus or minus 5% for major dimensions (except for hull depth covered under construction). The 5% does NOT apply to guns, torpedoes, speed, or pressure.
- All vessels must be certified before competing, but need not be re-certified unless modified.
- Repair of battle damage does not require re-certification.
- Vessels may be certified for speed at any event.

B. PENETRATION CHALLENGE TEST

- The challenger and the challenged must have combat ready ships on hand for testing. The test shall be conducted on both ships with a 1/4" caliber gun that has been adjusted to penetrate – just to the point of breaking the surface of the backside from 12" away – the 2" foam used for gun checks at that day's event. This gun shall be placed perpendicular to the hull at a distance of 12", and fired into a penetrable window of the boat. The placement of the shot is up to the challenger and vice versa.
- If the first shot penetrates, the ship passes the challenge. If it fails to penetrate, two more test shots will be performed in two different locations. If both of these shots penetrate, the ship passes. If either one of these additional shots fail to penetrate, the following penalties will be assessed against it: 1) For the last sortie in which the ship participated, it shall be scored as having surrendered; 2) it will not be allowed to battle again until it has been re-sheeted. If a person refuses to have his ship tested after being challenged the same penalties apply.

C. RESPONSIBILITY

- The ship's skipper is responsible for bringing all technical information to the Technical Officer when requested, to certify that vessel.
- If the ship does not conform to the rules defined in [Chapter I – Construction](#), it will not be allowed into competition.

CHAPTER VII - COMBAT RULES

A. REQUIREMENTS FOR COMBAT ELIGIBILITY

- A certified vessel
- \$5.00 fee per game if not a WWCC member.
- NAMBA membership & insurance (required for captains of all vessels)

B. EVENT COMBAT SCHEDULE

- 11:30 AM: end of "open pond".
- 12:00 Noon: first sortie begins.
- 1:30 PM: second sortie begins.
- 3:00 PM: third sortie begins.
- 4:00 PM: fourth sortie begins.

Members will be notified by club bulletin if the upcoming event will contain long sorties (over 20 minutes) or campaign games, to allow the membership to prepare for using extra batteries, ammunition, and CO2 stores. The event director, at his sole discretion, may accelerate or delay the sortie by 5 minutes. The combat director and the event director shall enforce these starting times. If a combatant, chosen for a team, has reason to believe he will not be able to compete in the next sortie, he must inform the combat director of his intention to officially withdraw not later than 5 minutes prior to the start of the sortie. Any combatant, chosen for a team, who has not officially withdrawn from the next sortie, must sail his vessel out of port not later than 10 minutes after the start of battle. If he fails to do so, his team shall be assessed a 25-point penalty.

Club members and their invited guests may use the pond on battle days before 11:30 AM for anything related to scale RC warship modeling. All ships shall be electric powered and shall conform to WWCC safety standards. Live firing shall only be allowed when a Safety Officer or CD is present and in control of pond access. All firing shall stop at 11:00 AM to allow late arrivals to set up. VISITORS MAY NOT FIRE GUNS.

C. TEAM IDENTIFICATION

- Each vessel must be equipped with at least one mast in the prototype position, to which a 2-inch team flag may be attached. If the prototype vessel did not have a mast, a vertical radio antenna may be substituted.
- Team flags shall be attached when so designated by the Combat Director, who will supply the tape

to be used.

D. PORT RULES

- Each team shall have a port with clearly marked boundaries.
- Once a 15 or 20-minute sortie begins, the following rules apply.
- No shooting into or out of port.
- Ships equipped with non-reloading torpedo systems may return to their home port for reloading an unlimited amount of times and depending on what is needed, may be reloaded in or out of the water. During regular combat sorties, the ship must round a convoy buoy (or in the absence of a buoy, a convoy route turn-around point) prior to coming back to port for torpedo reloading. The combat director shall enforce the rounding of the buoy for all non-compliant vessels.
- Time in port for reloading such systems shall not exceed two minutes per occasion unless extended by the combat director, prior to the sortie. Except for the purposes of reloading as described above, visits to port are limited to a maximum of three, not to exceed one minute per visit, unless otherwise authorized by the Combat Director. Any ship violating this rule shall be pulled and declared surrendered.
- Temporary fixes in port are limited to clearing rudders and props of debris, repositioning a superstructure or turret that has become dislodged during the event, or turning on gas valves that may have been forgotten at original launching. Other allowances may be made at the discretion of the combat Director.
- No under-deck repairs or adjustments are allowed, with the exception of activating a switch or valve. Typically, this means that no deck pieces may be removed unless approved by the combat Director.
- Blockading of ports is not allowed. Enemy ships shall stand off at least 10 feet from port boundary to allow reasonable access to port or exit from port.

E. CONVOY VESSEL OPERATION

- [\(See Chapter I – Construction – Design – Convoy vessels\)](#)
- [\(See Cargo Points\)](#)

F. RAMS

- A collision between two ships is defined as a ram only when the bow or stern of the offending ship collides with the beam (or side) of the victim, and causes either an uncorrectable list or outright sink. Beam-to-beam contact between two ships that results in loss of stability or a sink is not a ram.
- A ram is also the purposeful obstruction of an obviously sinking ship returning to port.
- The event officer has the final pond site authority to determine if a ram has occurred, to determine who is at fault, and to assign penalties, if any.

Conditions:

Ramming is permitted only as follows:

- Submarines may ram any vessel or structure. Sub actuators may not damage the target ship. If the actuator is determined by the CD to have damaged the target hull, a ram value shall be assessed against the sub.
- Convoy vessels may ram any other ship.
- Surface combat ships shall not ram other surface ships, including convoy ships.
- Ramming of structures is not permitted, except as noted.

G. COMBAT DYNAMICS: “FAIR GAME”

- Once a sortie begins, all ships afloat outside of port are fair game - even if disabled – unless the captain or Combat Director declares it to be surrendered.
- If so declared, the surrender is scored as specified in Chapter X, Scoring.

H. SINKING – DEFINITION

A ship is considered sunk if any of the following conditions apply.

- The main deck is 60% awash
- It is beached and the keel is on the bottom
- Its captain surrenders
- It sinks outside of port within 5 minutes of “cease fire” being called.

I. BEGINNING AND ENDING COMBAT

- The Combat Director will start a game by announcing "COMMENCE FIRING"
- The Combat Director will stop the game by announcing "CEASE FIRING."

J. Right of way

- When two ships are on a collision course, both ships shall make a right turn to avoid a collision.
- If neither ship chooses to stop or reverse course then both ships may receive a one-minute cease-fire.

K. EVENT OFFICERS

1. Event Director (EvD)

- Unless waived (see below), all events shall have an EvD, who shall be in charge of overall management of the event, scoring and judging any infractions, such as rams.
- An EvD must be of Captain or higher rank. If no qualified member volunteers for EvD, then a

lottery may be held to determine which [qualified] club member will serve in the position.

- Events where eight or fewer ships are participating may waive the requirement for an EvD; however, all combat events must have a Combat Director.

Responsibilities of an Event Director:

a) Ensure that all the proper equipment is brought to the pond. The EvD does not have to personally bring the equipment but must contact the appropriate person/s to ensure it is brought to the pond on the event day. If there are problems with getting the equipment to the pond, he shall make arrangements to get the equipment to the pond. The equipment includes but is not limited to the following:

- CO2 sufficient for the event, fill station & wrench, scale, and straps to secure tanks
- Safety equipment (delineators, rope, safety glasses, first aid kit)
- Retrieval Boat, oars and air pump, personal flotation devices, recovery equipment
- [Course] Floats, rods (port markers)
- Forms for recording scores, voting, membership and NAMBA
- Trash bags
- Club canopy
- Testing equipment (gun checks and speed checks)

b) Ensure that proper setup and tear down takes place at the pond and that no trash or other items are left pond side.

c) Ensure there is a Combat Director (CD) for each battle

d) Ensure along with the CD that scoring is done and the results are reported to the club (at the event and also to the president for rank purposes)

e) Ensure that voting is done pond side for Best Over 20K, Best Under 20K, Best Cargo, Best Detailed Ship of the day and ensure that the results are reported to the club (at the event and also to the president for rank purposes)

f) Ensure, along with the Safety Officers, that the safety rules are being followed

g) Ensure that gun checks and speed checks are performed as necessary

2. Combat Director (CD)

- Only those members with a rank of Lt. Commander or above may serve as CD.
- The CD's position exists only during the sortie or campaign game in which he serves.
- While serving in this position, the CD has the ultimate authority to make judgments relative to the sortie, within the framework of the club's rulebook.
- The decision of the CD is final!

3. Technical Officer

- Inspects vessels for compliance with club construction and safety rules
- Makes vessel records available at all events, as directed by the club president.

4. Safety Officer

- Responsible for safe setup and operation of all CO2 fill station equipment.
- Enforces all club safety rules, both on the pond and in the pit area

CHAPTER VIII - SCORING

A. DAMAGE POINTS

ACTION	POINTS
Penetrate enemy ship's hull or shore battery above boot*	3
Penetrate enemy ship's or shore battery's boot*	5
Penetrate enemy ship's hull or shore battery below boot*	10
Convoy vessel successfully completing one lap of a course designated by the Combat Director	10 points – Small Convoy ship 15 points – Medium Convoy ship 20 points – Large Convoy ship 30 points – Extra-large Convoy Ship see Cargo Points
Strike enemy ship with aircraft (Only carriers may launch aircraft for points)	20
Shoot enemy dockside target off dock	5
Sink enemy shore battery	30 + damage

Fig. 9 Damage Assessment Chart

***Note:** If a bb hole touches a black or red painted area of the hull, this hole will be counted and scored as a hole in the black or red respectively.

B. SINK VALUES

SHIP DISPLACEMENT	POINTS
0 to 20,000 tons	20 + damage
20,001 to 30,000 tons	40 + damage
30,001 to 50,000 tons	60 + damage
50,001 + tons	80 + damage

Fig. 10 Sink Scoring Chart

C. Other Scoring Values (see notes below chart)

ACTION	POINTS
Failure to leave port within 10 minutes of calling “commence fire”	25
Do not return to port (DNR)	25 + damage
Surrender	20 + sink value computed from Fig. 9 above
Ram (1 st offense)	25
Ram (2 nd offense)	50
Ram (3 rd offense)	Boat removed from pond
Damage to victim from ram (scored against rammer)	Double damage points
Ram that sinks victim (scored against rammer)	Triple normal sink points

Fig. 11 Other Scoring Values Chart

Note: If it has been determined that a submarine’s torpedo activation plunger trigger has damaged a hull, a ram will be scored against the sub as per above chart.

“Other Scoring Values” Chart Notes

- **Do not return to port (DNR):** If a ship does not return to port - either under its own power or pushed into port by another ship - within five minutes of the call of Cease Fire, that ship shall be considered a DNR and scored as such. If a ship sinks outside of port within the 5 minute period it shall be scored as a sink.
- **Surrender:** A ship is considered surrendered under the following conditions.
 1. A captain declares that he surrenders
 2. A captain pulls his obviously sinking ship from the water, before it is decks awash.
 3. The Combat Director acts within his authority to pull a ship from combat in response to rule violations as specified elsewhere in this document.
- **Rams**
 1. All rams also have a one-minute cease-fire on the offending vessel.
 2. Rams that occur between ships on the same team shall not be penalized.

D. CARGO POINTS

- Convoy vessel score cargo points (equivalent to damage points) against the other team when they complete a lap of a course designated by the Combat Director. The score per lap will be determined

by the size of the ship as measured by overall length of the model; extensions or other details not integral to the hull are not included in the measurement of the overall length.

Convoy Vessel Scoring Chart		
Ship Size	Model Overall Length	Points Per Lap
Small	up to 28"	10
Medium	28" up to 40"	15
Large	40" up to 48"	20
Extra Large	48" or more	30

Fig. 12 Convoy Vessel Scoring Chart

E. POINTS AWARDED TO INDIVIDUAL SKIPPERS

1. **Combat Points:** are awarded for participation in regular sorties, campaign games, last man standing battles, and for winning in field Captain's Choice Awards. Combat points may also be awarded to individuals for participation in non-team/non-sortie combat events. Combat points to be awarded to players shall be determined by the combat point charts below. (fig. 13, fig 14)

Combat Points for Combat Participation:

SORTIE/CAMPAIGN	WINNING CAPTAINS	LOSING CAPTAINS	COMBAT DIRECTOR
Up to 20 minutes	5	3	5
21 - 45 minutes	10	6	5
46 – 120 minutes	30	18	5
Over 2 hours	50	30	5
Last Man Standing	20 winning	10 for participating 5 for surrendering	5

Fig.13. Sortie Combat Points

Combat Points for Captain's Choice Awards:

Award	Points
Best Captain in the over 20,000-ton vessel class	2
Best Captain in the under 20,000-ton vessel class	2
Best Captain Convoy Vessel class (if used in event)	2
Best Detailed Ship (that operated in event)	2

Fig.14. Captain's Choice Combat Points

F. MANEUVERING and GUNNERY POINTS

Earned per game in maneuvering and/or gunnery events (**Note: M&G ships need not be penetrable.**)

Award	Points
Participation award (all participants)	1
First Place	5
Second Place	4
Third Place	3
Fourth Place	2
Fifth Place	1

Fig.15 Maneuvering and Gunnery Points

G. SERVICE POINTS

Service	Points
Combat Director (full day)	5
Combat Director (less than full day)	1 point per sortie, 5 max
Referee	4
Event Director	4
Scoring	3
Speed / Gun Safety Certification	3
Setup / Cleanup of event	3
Timer	2
Provide unarmed vessel for others' use	2
Operating an unarmed convoy vessel	1 point per sortie
President of club	10 per year
Vice-President of club	8 per year
Secretary/Treasurer of club (beginning '04)	9 per year

Fig. 16 Service Points

H. PRESIDENT'S AWARDS

- For services as deemed worthy by the Club President
- Quantity of points to be determined by the President
- Must be approved by two or more additional club officers.

I. RANKING

Rank	Combat Points	Maneuver Points	Service Points	*EvD Points
Lieutenant (JG)	Launch a combat certified ship			
Lieutenant	50	5	10	0
Lt. Commander	100	10	20	0
Commander	150	15	30	0
Captain	225	40	80	0
Commodore	300	60	110	1
Rear Admiral	400	85	150	2
Vice Admiral	550	115	200	4
Admiral	750	150	260	6
Fleet Admiral	1000	190	330	9

Fig. 17 Points Accumulation/Ranking Qualifications

- To rise in rank, you must achieve points as shown in Fig. 15.
- Keeping track of all points accumulated, rank, status and awards is the responsibility of the President and will be posted periodically.

*Notes on EvD Points

Those people who have already obtained a flag rank (Commodore or higher) need only do the difference in the number of events to advance to the next rank *per the below chart*. A person must be an EvD the number of times indicated AT THAT RANK and can NOT carry extra EvD jobs forward between ranks. For example: a person serves twice (2) as an EvD while a Commodore but only one counts towards the eventual total. This means a person cannot, for example, do five EvD jobs as Commodore and four EvD jobs as Rear Admiral and then do nothing for Vice Admiral, Admiral and Fleet Admiral.

Rank	Maximum EvD service credit toward advancement
Commodore	1
Rear Admiral	1
Vice Admiral	2
Admiral	2
Fleet Admiral	3

Fig. 17-a EvD Advancement Limits per Level of Rank

If during the event there are indications that the EvD has not performed the required duties as defined in the EvD job description, the club officers present may elect to do the following:

- a) Check to see if all of the items on the checklist have been completed.
- b) If some or most of the items on the checklist have not been completed, an officer will query the other officers to get their feedback.
- 3) If the feedback is negative, the officers can vote to not award the person the EvD point for rank. (If the EvD in question is one of the officers, he must abstain from voting.)
- 4) if the officers vote to deny advancement credit for that EvD service, they must prepare and submit a list of items not completed.
- 5) The officers will then inform the person that the EvD point is not being awarded, and why.

Event Director Checklist

- _____ 1) Contact the President and determine if there is a special type of battle he wants for that event (different rules or length of time for battle).
- _____ 2) Contact the Secretary and notify him of any particulars for the battle (especially from #1)
- _____ 3) Contact the Secretary and ensure he bring all of the forms needed to the pond
- _____ 4) Contact the Safety Officer(s) and make sure that the safety equipment (pylons, rope, safety glasses, first aid kit) is brought to the battle.
- _____ 5) Contact the appropriate person(s) to ensure that the CO2 tanks are filled; fill station brought along with wrench, strap to secure the tanks to the tree, and scale.
- _____ 6) Contact the appropriate person(s) to ensure the inflatable boat, accessories and floats used for courses/harbors/freighter routes are brought to the pond.
- _____ 7) Contact the appropriate person(s) to ensure that foam or the testing device is brought to the pond to do gun checks and speed checks.
- _____ 8) Ensure the proper setup and teardown takes place at the pond. (Safety equipment, CO2 supplies, boat, trash picked up, everything gotten to appropriate person)
- _____ 9) Ensure that there is a Combat Director, Timer and Scorer (all, some or none may be done by EvD or request volunteers for each job) for each battle.
- _____ 10) Ensure that scoring is done after each battle and the results are reported to the members present. Also ensure that the person who keeps track of overall scores (usually the President) gets the score sheets at the end of the event.
- _____ 11) Ensure that voting is done pond side for Best Over 20K, Best Under 20K, Best Cargo, Best Detailed Ship of the day and ensure that the results are reported to the club (at the event and also to the president for rank purposes).
- _____ 12) Ensure that all the equipment gets stored or with the appropriate person(s) to take care of it at the end of the battle.
- _____ 13) Handle or delegate to appropriate person(s), any items or problems that crop up during the event
- _____ 14) Ensure along with the Safety Officer(s) that all the safety rules are being followed (especially concerning eye protection)

CHAPTER IX - GRANDFATHER CLAUSE

In recognition of the fact that club rules occasionally change, to the effect of making a legal vessel illegal, the following process will govern WWCC's policy for those conditions.

A. DEFINITION: Grandfathering is a term used within in our organization to describe ships that have been made illegal as the result of a rule change. It is "not" a ship that has been built in violation of a rule and subsequently "forgiven." (Such ships shall be corrected to the rules or the rules shall be changed to include the ships as built.)

B. AUTHORITY: Grandfathering is determined and granted by the WWCC senior officers (President, Vice-President, and Secretary/Treasurer) at their discretion.

C. APPLICATION:

1. Effects on ship structure = Lifetime grant.
2. Effects on armament or pumps = Grandfathered for 120 days from January 1st when most new rules take effect, or from the date of achieving 2/3rd majority, if the applicable rule is effective immediately. (from when the rule takes effect – eliminate Jan 1).
3. Effects on speed = Must conform at next event after 2/3rd majority passage of rule (when the rule take effect).
4. Effects on armor thickness = Grandfathered for one year from the January 1st, or from date of achieving 2/3rd majority, if applicable rule is effective immediately. (from rule take effect)
5. Effects on elimination of class or type of ship = Case by case re: senior officers
6. Documentation- To be developed after a ship has been established as grandfathered. Such documentation will be issued and kept as part of the ships' certification or pedigree, one copy to be retained by ships owner and one copy to be kept by WWCC Secretary. (May be computer record.) A ship without documentation is not grandfathered!
7. Description of documentation – To be developed
8. A ship's current owner is solely responsible for compliance to all rules.

D. Grandfathered Ship Classes

- All grandfathered non-launched ship classes shall be eligible for new construction and combat. The drawing source for existing non-launched ships shall be stated and an archive copy of the

drawings shall be provided to the club. New non-launched ship model construction shall be based on the archive drawings and the key statistics noted in the table below.

- The following non-launched ship classes are grandfathered:

<p>Alsace</p> <p>Length: 886'-0" oa (scale: 73.8")</p> <p>Beam: 116'-7" (scale 9.7")</p> <p>Armament: 12-15" in 3x4, 12-6" in 4x3, 16-3.94" in 8x2, 32 - 1.46" in 8x4</p>	<p>Displacement: 45,000 std / 55,102 full</p> <p>Main armor belt thickness: 14.17"</p> <p>Maximum speed: 30 knots</p> <p>Drawing source: Jim White (<i>see also, Allied battleships of WWII, Garzke/Dulin/Webb</i>)</p>
<p>Kreuzer 'P'</p> <p>Length: 731'-7" wl, 754'-7" oa (scale: 59.74" to 66.02" oa)</p> <p>Beam: 88'-7" (scale: 7.38")</p> <p>Armament: 6-28cm in 2x3, 4-15cm in 2x2, 8-10.5cm in 4x2, 8-3.7cm in 4x2, 6-53.3cm TT Fixed Underwater</p>	<p>Displacement: 22,145 std / 25,689 full</p> <p>Main armor belt thickness: 5.71"</p> <p>Maximum speed: 34 knots</p> <p>Drawing source: <i>Groner, Erich: German Warships 1815-1945, Vol. 1</i></p>
<p>Gascoigne</p> <p>Length: 813'-2" oa (scale: 67.76" oa)</p> <p>Beam: 108'3" (scale: 9.02")</p> <p>Armament: 8x 15" (2x4 split fore and aft), 9x 6" (3x3), 16x 3.9" (8x2)</p>	<p>Displacement: 35,000 std</p> <p>Main armor belt thickness: 13.5"</p> <p>Maximum speed: 33 knots</p> <p>Drawing source: Conway's</p>
<p>Scharnhorst Class (6 x 15" Gun version)</p> <p>Length: See Conways</p> <p>Beam: See Conways</p> <p>Armament: Main armament 6 x 15" (2x twin turrets forward, 1x twin turret aft), Secondary and tertiary armament as per Conways</p>	<p>Displacement: Conway's</p> <p>Main armor belt thickness: Conway's</p> <p>Maximum speed: Conway's</p> <p>Drawing source: Conway's</p>

Fig. 18 – Current Grandfathered Ships

The table above shall be revised as required to incorporate the classes of all **existing** (as of August 2009) models of non-launched ships that are not clearly defined in Conway's. The key statistics noted in this table and archive drawings are intended to allow for the construction of essentially equivalent models within a ship class.

Chapter X - NEW TECHNOLOGY

A. NEW WEAPONS

- Trial Period:
 1. New weapons must be approved by at least 3 club officials prior to trials.
 2. Trial period will be 3 events.
- Voting on Use:
 1. After trials, a vote may be taken on the continued use of the new weapon.
 2. If passed, its use may continue for the rest of the year.
 3. A final vote on permanent use must be submitted in writing for the following years ballot

B. NEW, NON-WEAPON TECHNOLOGY

- New technology, other than weapons, may be used as long as it does NOT violate any of the rules dealing with ship construction and/or operation.
- All members must be informed of the new technology before its first use in combat.

C. PROPOSED NEW TECHNOLOGIES

- None current under testing

APPENDIX A. – CHANGES IN THE RULEBOOK FOR 2011 - 2014

Change record for CY2011

- New 2/3 majority requirement for a rule change petition process introduced to replace the previous simple majority rule change process. Note that officer elections process remains unchanged.
- Addition of club member authorization by vote to create Bylaws, Construction, and Game Play sections of the rulebook, subject to final approval by 2/3rd majority.
- Armament allowances for Aircraft Carriers in excess of 45,001 tons have been increased, which affects only 3 carriers. See [Pump and Armament Allocation Charts 6a-6b](#).
- All convoy vessels are restricted to a maximum speed of 25 knots only, regardless of the speed of the prototype.
- Incorporated the new Convoy Vessel scoring system, which is based on the size of the convoy ship, in combination with the number of laps completed of a designated course.
- Added newer, clearer definition of “Main Deck”
- Documentation requirements for rule clarifications and distribution added for the “transparency and accountability” proposal.
- Grandfathering of an alternate version of an existing ship – something normally not allowed – in this case the alternate Scharnhorst class with 6 x 1/4” guns in 3 twin turrets, based on the historical alteration of the actual DKM Gneisenau of the same class – the Grandfathered ship is specifically Joe Moore’s original combat model. See [Chapter IX – Grandfather Clause \(Waivers\)](#)

Change record for CY2012 -CY2013

- Added one new rule change that passed in 2012: Event Director requirements for flag rank advancement. See text, ranking chart and advancement chart on page 34, and Event Director Checklist on page 36.
- Added under Proposed New Technologies Substitution of duct tape for balsa skin on club-owned loaner convoy vessels.

Change record for CY2014

- Removed club administration section as these are now contained in the Club Bylaws.
- Updated document chapter numbering to reflect removal of the administration section.
- Added APPENDIX C: WWCC, INC. VOTING RULES (Construction, Engineering and Combat)
- Substitution of duct tape for balsa skin on convoy vessels: approved by BOD for club-owned unarmed loaners, only, 18 Feb 2014 .

Change record for CY2016

- The use of duct tape as an option for hull construction is approved for general use in all ships.
- Duct tape use removed from the experimental technologies section of the rulebook and incorporated into construction rules as an option to balsa wood.

APPENDIX B: AIRCRAFT GUN BARREL PLACEMENT GUIDELINES

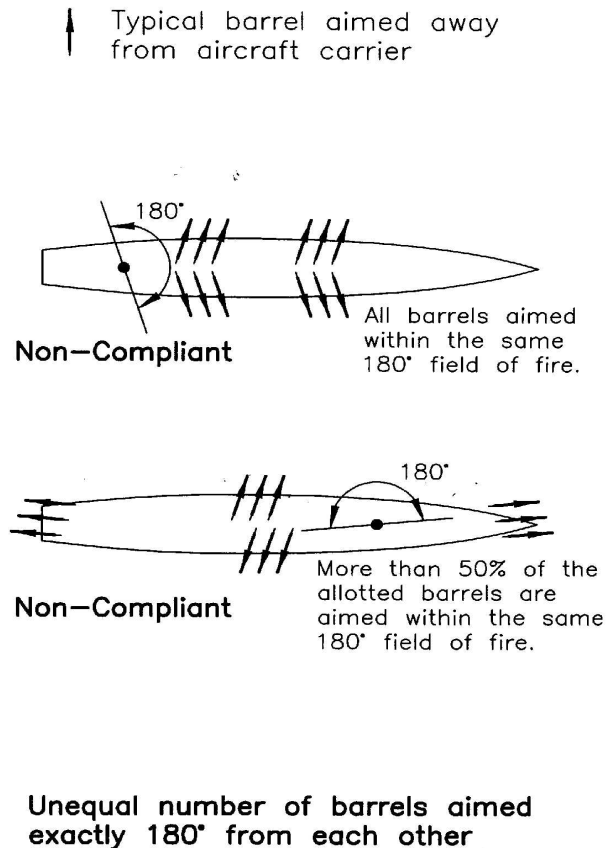
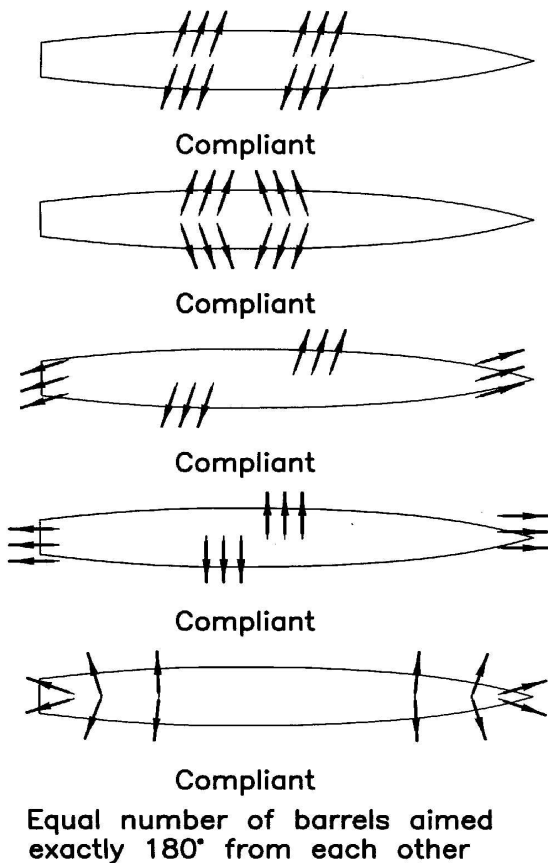

NOTES:

1. The field of fire rule only applies to "GUNS" (up to and including 1/4"). The field of fire rule does not apply to "ADDITIONAL SMALL GUNS" (4 x 3/16").
2. This figure is a graphic interpretation of Figure 6a and its accompanying notes. The text and notes on this figure are commentary and do not supersede the text within the rule book. This figure is intended to be an aide to minimize differing or erroneous interpretations. All examples shown are for an aircraft carrier with twelve 1/4" guns maximum. Other gun maximum groupings are similar.
3. A barrel aimed exactly 180° from another barrel (parallel, but in the opposite direction) is NOT considered to be in the field of fire for the other barrel. A barrel aimed less than 180° from another barrel is considered in the field of fire for the other barrel.
4. The reference line to determine the field of fire may be at any angle with respect to the aircraft carrier and shall be oriented to represent the worst case.
5. An aircraft carrier equipped with the maximum number of 1/4" guns requires each barrel to have another barrel aimed exactly 180° in the opposite direction.

APPENDIX C: WWCC, INC. VOTING RULES

VOTING (Administrative)

- Member Voting Eligibility: See WWCC, Inc. Bylaws: **ARTICLE II - MEMBERSHIP**
- Elections of directors & officers: See WWCC, Inc. Bylaws: **ARTICLE VIII – ELECTIONS; VOTING**

VOTING (Safety Rules)

- Revising or adding safety rules are an administrative duty of the WWCC, Inc. Board of Directors.

VOTING (Construction, Engineering and Combat Rules, only)

- Temporary waiver: *Any rule may be temporarily waived for the duration of one single sortie if a 2/3rd majority of the captains who are participating in that same sortie vote in favor of doing so, unless the waiver would violate safety rules, or any rule that is required by NAMBA, by any governmental agency, or by the terms of any contract entered into by the club leadership.* For example, If there is a legal issue with a particular ship, a temporary waiver may granted to a single ship on 2/3rd approval of the skippers participating in that sortie, to allow the ship to participate for a single sortie. All temporary waivers are effective for the one single sortie only. A new vote per sortie will be required to continue the waiver for each subsequent sorties. *This does not apply to*
- Long Term Waiver: An exception (i.e. a waiver) to any construction, engineering or combat rule may be granted to a specific situation, a ship, a skipper, or any other special circumstance on a long term or permanent basis, if it is approved by 2/3 of all eligible members. *This does not apply to safety rules, or to any rule that is required by NAMBA, by any governmental agency, or by the terms of any contract entered into by the club leadership.* The petitioning procedure for granting a long term waiver shall be the same as the procedure for the rule change petition process. The wording, specific circumstances of the long term waiver, effective date, and the duration of the waiver must be clearly defined in the petition wording. If the long term waiver is approved by the club, it shall be publicized by club officers via club wide announcements. If the waiver is to be effective beyond the year in which it was approved, it must be documented in the next edition of the rulebook until the expiration of the waiver, when it can be removed.
- Rule changes: A permanent rule change requires that a proposal, put forth as a petition by an eligible member, receive support signatures from 2/3rd of all eligible member. See section “Voting: Rule Change Petitions” for details of the process.
- Where the interpretation of a rule, or an exception to a rule, is not clear or is in question, the WWCC President (or in his absence, the Vice-President) shall provide a temporary ruling on the field. Such temporary rulings must be documented and published; [see Documentation](#).

E. VOTING (Awards)

1. Captain's Choice Field Awards

Members cast votes for the following Captain's Choice Field Awards at combat events for outstanding play and craftsmanship. A member must be present to cast his vote for Captain's Choice. These awards are used to determine the overall winner of various year-end awards:

- Best Captain operating a ship over 20,000 tons
- Best Captain operating a ship under 20,000 tons.
- Best Captain operating a convoy vessel.
- Captain operating Best Detailed Ship.

2. Year End Awards and Standards

These are presented at the award banquet held the second Sunday of December or January in a pre-determined location:

- First Place Overall... determined by who earned the most points overall for the year.
- Combatant of the Year... determined by who earned the most combat points for the year.
- Helmsman of the Year... determined by who earned the most G&M points for the year.
- Meritorious Service... determined by who earned the most service points for the year.
- Captain of the Year Over 20K... determined by who won the "best Captain operating a ship over 20,000 tons" award the most times for the year.
- Captain of the Year Under 20K... determined by who won the "best Captain operating a ship under 20,000 tons" award the most times for the year.
- Convoy Captain of the Year... determined by who won the "best Captain operating a convoy vessel" award the most time for the year.
- Best Detailed Ship of the Year... determined by the ship that earned the most detail points for the year.
- Rookie of the Year... determined by the rookie that earned the most points for the year.
- Captain's Choice Award... determined by vote, the captain you most want on your team.
- Most Feared Captain/Ship... the captain/ship combination you do not want to battle the most.
- Naval Engineering Award... determined by vote.

F. VOTING: (Rule Change Petitions for construction, engineering or combat rules)

1. Submitting the Rule Change Petition

- The process for petitioning the club to change the rules starts no earlier than April 1st. The final support signature is due on November 30th. These dates define the rule change petition period.

- Eligible members are allowed to submit only 1 rule change petition per voting period.
- Rule changes are effective as of January 1st the following year, unless clearly specified otherwise in the text of the published petition.
- A petitioner is responsible for initiating the process by circulating a rough draft to collect the signature from 5 backers among members eligible to vote. Once the petitioner presents the draft in writing via email or paper to the Club Secretary, along with paper or emailed support from the 5 initial backers, the draft can be accepted and the certification process begins.

2. Certifying the Petition

- The petitioner and the club officers must work together to produce a final draft of the petition that clearly spells out the exact wording and details of the proposal, the sections in the rulebook affected by the change, and what those changes are going to be. Note: If the petition is intended to be effective immediately upon passage, the final draft must explicit state so, and also be detailed enough to serve as the rule until the rulebook is updated at the end of the year.
- The detailed draft of the petition must be certified by a simple majority of all club officers before it can be published and circulated for signature gathering. Club officers may vote to withhold certification of the petition only on the following grounds: A) that the petition still lacks sufficient details so as to be misleading, and B) doesn't properly address how the proposal is to be integrated into the rulebook. Once a majority of all club officers vote to certify the petition, it will be published electronically by club officers, for discussion and clarification in a moderated discussion forum.
- Once published, a certified petition may be modified by the petitioner, but A) any modification is only limited to minor changes and must be on the same subject matter, since a member is limited to one proposal per year. B) it must go through the certification process once more, and C) all signatures gathered so far is null and void, and the signature collection must start from scratch again.

3. Signature Gathering

- It will be the petitioner's responsibility to collect support signatures for the proposal.
- The petitioner may circulate the petition on paper and obtain signatures so long as the paperwork meets the following requirement: A) Each page with signatures must have the text of the certified petition at the top; B) each signature must have a clearly readable printed name, and the signature date. All paper signatures are subject to verification by the 3 officers performing the count. In case of multi-page petitions, the proposer will work with the club officers to determine a method where the signatures can be firmly associated with the correct version of

the proposal.

- Computerized signature gathering can be used in lieu of, or in combination with, paper signatures. A secure electronic voting system may be setup and administered by club officers only. A club member who signs both a paper petition and also signs the petition electronically will be counted as submitting only one single signature.
- Signatures may be collected throughout the entire petition period.
- A club member may change their vote and withdraw support from a fully certified and published petition only if 2/3 majority has not been achieved. Once 2/3rd majority is achieved, members cannot change their vote.

4. Signature Counting

- Once the petitioner believe that a 2/3 majority has been achieved, the petitioner will request a formal vote count as of a specific date, called the “petition signature count” date. The petition passes if 2/3rd of the total eligible members on the club roster as of that date support it. *(For example, believing that 2/3 support has been achieved by mid-July, a petitioner might request July 22 as the “official petition signature count date.” If 2/3rd of the eligible members in the club as of July 22nd support the proposal, it passes).*
- If the petition fails to achieve 2/3rd, it may still continue to collect signatures until a later date when the petitioner may request a new petition count date. If the petition obtains 2/3rd of the eligible membership count as of the new date, then it passes. *(For example, if the initial vote count on July 22 fails to achieve 2/3, the petitioner may request another official petition count date on August 30th. If the membership roster has changed since July 22, the 2/3rd threshold will be different because the membership count as of August 30th is different).*
- The last possible petition count date and the last opportunity to achieve 2/3rd is November 30th. The petition expires if it fails to obtain 2/3rd signature support and cannot be submitted until next year.
- Petition count results shall be published as soon as possible after the results are known.

5. Rulebook Updates

- Since all rule change petitions take effect January 1st the following year, the rulebook will only be updated once, at the end of the year, to reflect all passed proposals during the year.
- Rules that go into effective immediately or sometimes during the same year will use the certified approved petition text as the rule, until such time at the end of the year when it can be incorporated into next edition of the rulebook.